

Made in Italy



IP67



COAST



IK10



ANSI 3G



DMX 512

DATASHEET & USER GUIDE

XLED-LINE-EL44X-RGBW

SCOPE OF SUPPLY

Check completeness of supplied device immediately after receipt.

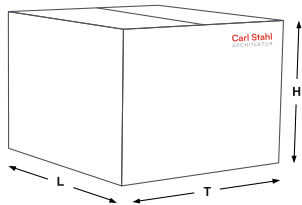

1 XLED-LINE-EL44X-RGBW

2 Datasheet & User Guide

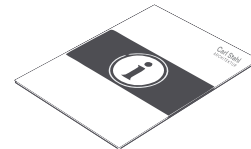

TRANSPORT AND SHIPPING

Our products are shipped in the following formats – Keep dry and protect from damage!

XLED-LINE-EL44X-RGBW

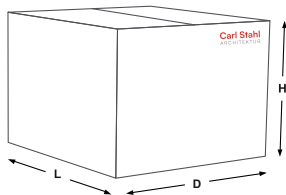

(max. 100x XLED-LINE-EL44X-RGBW)

Individual box

Weight: max. 425 kgs
 Dimensions (L x D x H) 120 x 80 x 100 cm
 47.24" x 31.50" x 39.37"

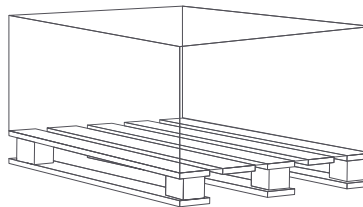

Euro pallet (Standard 800 x 1200 mm)

Pallet weight: 50 to 450 kgs
 Pallet height: 40 to 120 cm
 15.75" to 47.24"

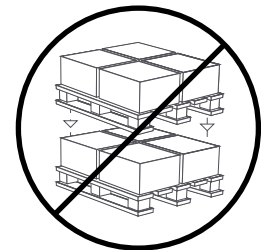

Euro pallet / Shipment

PRODUCT SPECIFICATIONS

XLED-LINE-EL44X-RGBW is the ideal solution for creating captivating full-colour sceneries, stunning lighting effects, and cutting-edge lighting design projects. It excels in applications such as interactive media facades, programmable skyline elements, catenary lighting, architectural and building illumination, innovative urban lighting concepts, and video mapping on façades, skyscrapers, and monuments – delivering a high visual impact.

It is equally well-suited for illuminating various ceiling types and constructing realistic, dynamic light sculptures.

Equipped with DMX-512A control and advanced LED technology, the system produces vivid colours and supports synchronized video content. Its low power consumption, robust construction, and IP67-certified LED Dots make it fully prepared for harsh environmental conditions, both indoors and outdoors.

Thanks to our numerous mounting clips, the system allows for quick and secure installation, making the **XLED-LINE-EL44X-RGBW** a flexible and efficient solution for both standard and complex lighting projects.

When combined with our **XLED-PS8-RDM**, the entire installation can be remotely monitored and controlled. The system offers real-time diagnostics and immediate error reporting, which minimizes downtime and significantly reduces maintenance efforts.

The customization options, including the number of dots, pixel pitch, cover type and finish, as well as housing and cable colours, allow the product to be tailored precisely to the architectural context and installation requirements.

The system is also designed for long-term reliability, using durable components that ensure stable performance and reduce the need for frequent servicing. This makes it especially suitable for installations in locations that are difficult to access or where operational continuity is essential.

Its thermal management system protects against overheating and ensures consistent output, even in demanding environments or during continuous operation.

Furthermore, the product supports industry-standard protocols, enabling seamless integration into existing lighting infrastructures and allowing centralized control of large-scale installations.

DIMENSIONS

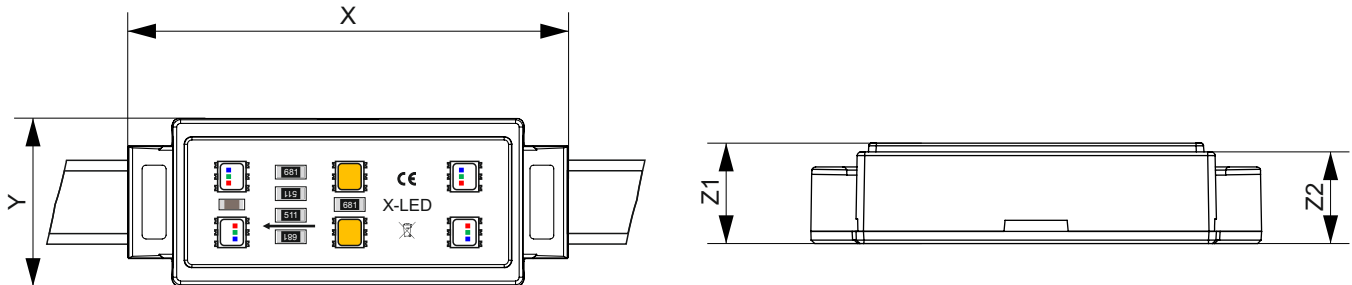

DIMENSIONS, STRUCTURE & MATERIAL

Module length [X] ¹	60.00mm (2.362")
Module width [Y] ¹	22.80mm (0.898")
Module height [Z1] ¹	14.10mm (0.555")
Module height [Z2] ¹	12.50mm (0.492")
Weight	17.50 gr.
Housing color	Black or Grey
Housing	UV stabilized, Polycarbonate
PCB color	Black or White
Potting color	Transparent
Lens Options	Clear or Diffused
Cover Lens	UV stabilized, Polycarbonate

Remarks: (1) according to ISO 2768-1m.

LENS & COLOR OPTIONS

EL44X-RGB (Black with white PCB)



EL44X-RGB (Black with black PCB)



EL44X-RGB (Black with Diffuser)

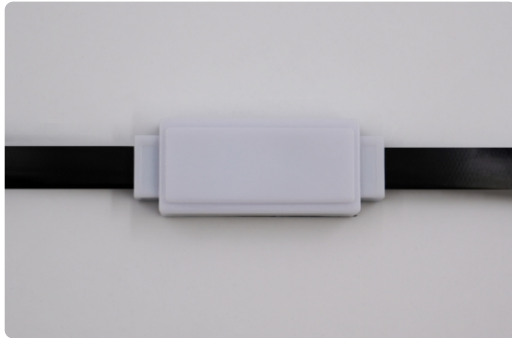

EL44X-RGB (Grey with white PCB)



EL44X-RGB (Grey with Diffuser)



PHOTOMETRIC CHARACTERISTICS (CLEAR LENS & WHITE PCB)

Color	Red	Green	Blue	White 4000K
Luminous flux [lm] ¹	5.1	15.9	3.9	23.0
Luminous flux (full-on/RGBW) [lm] ¹	47.9			
Efficacy (full-on/RGBW) lm/W ¹	39.9			
Efficacy (white) lm/W ¹	48.9			
Light quality [CRI]	85			
Luminous intensity RGB [cd] ¹	9.0			
Luminous intensity RGBW [cd] ¹	17.0			
Beam angle	115°			

Measurement Tolerances: (1) ± 5%

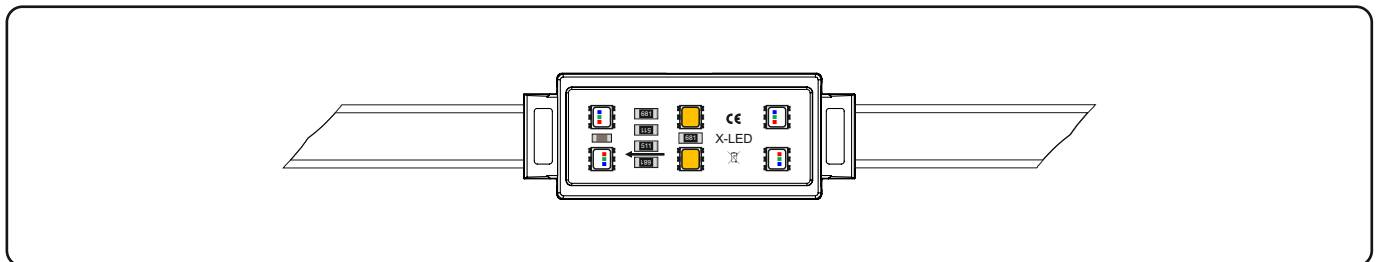

Candela Distribution

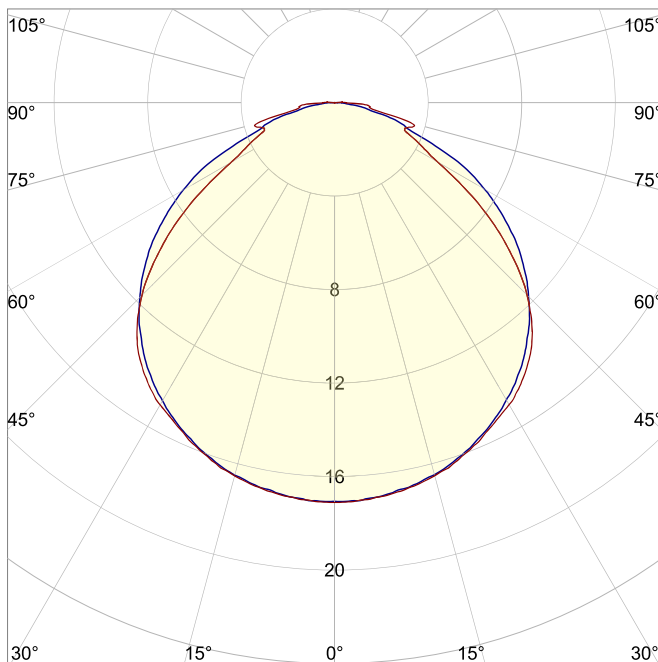

Spectra

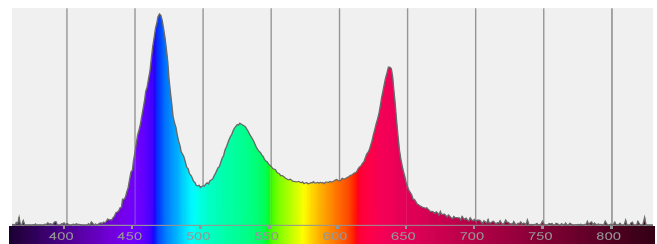

Beam details

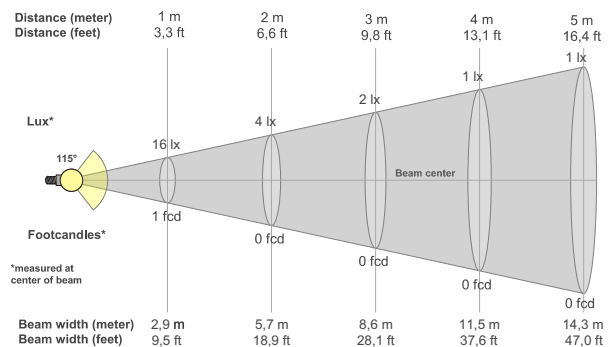

LDT/IES files are available on request

PHOTOMETRIC CHARACTERISTICS (CLEAR LENS & BLACK PCB)

Color	Red	Green	Blue	White 4000K
Luminous flux [lm] ¹	5.1	15.9	3.9	23.0
Luminous flux (full-on/RGBW) [lm] ¹	47.9			
Efficacy (full-on/RGBW) lm/W ¹	39.9			
Efficacy (white) lm/W ¹	48.9			
Light quality [CRI]	85			
Luminous intensity RGB [cd] ¹	9.0			
Luminous intensity RGBW [cd] ¹	17.0			
Beam angle	115°			

Measurement Tolerances: (1) ± 5%

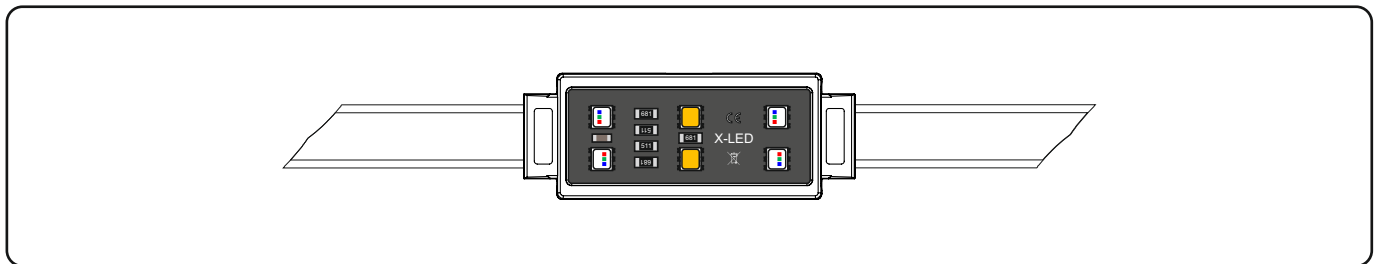

Candela Distribution

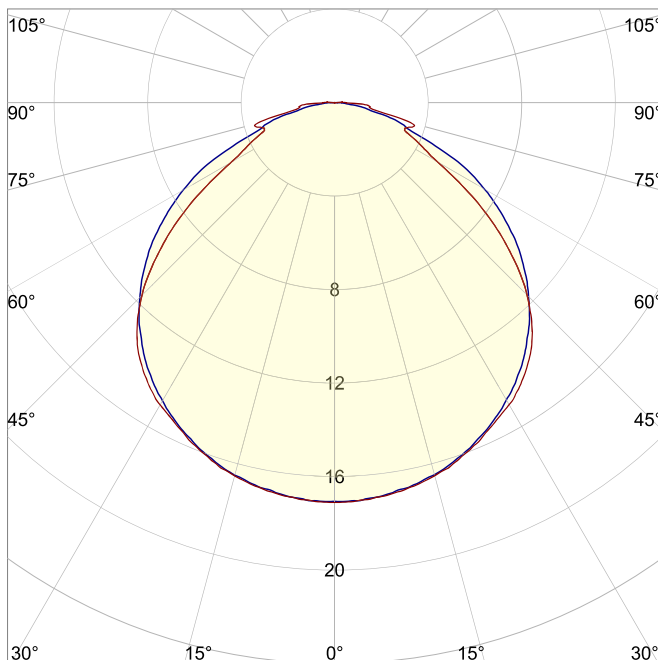

Spectra

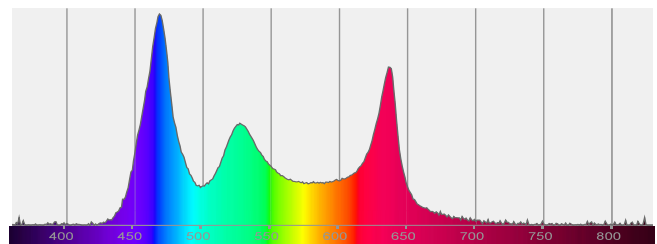

Beam details

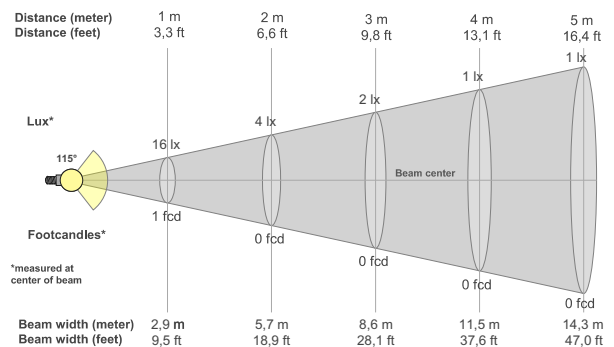

LDT/IES files are available on request

PHOTOMETRIC CHARACTERISTICS (DIFFUSED LENS)

Color	Red	Green	Blue	White 4000K
Luminous flux [lm] ¹	3.1	9.3	2.5	12.7
Luminous flux (full-on/RGBW) [lm] ¹	27.6			
Efficacy (full-on/RGBW) lm/W ¹	23.0			
Efficacy (white) lm/W ¹	27.0			
Light quality [CRI]	89			
Luminous intensity RGB [cd] ¹	4.6			
Luminous intensity RGBW [cd] ¹	8.6			
Beam angle	125°			

Measurement Tolerances: (1) ± 5%



Candela Distribution

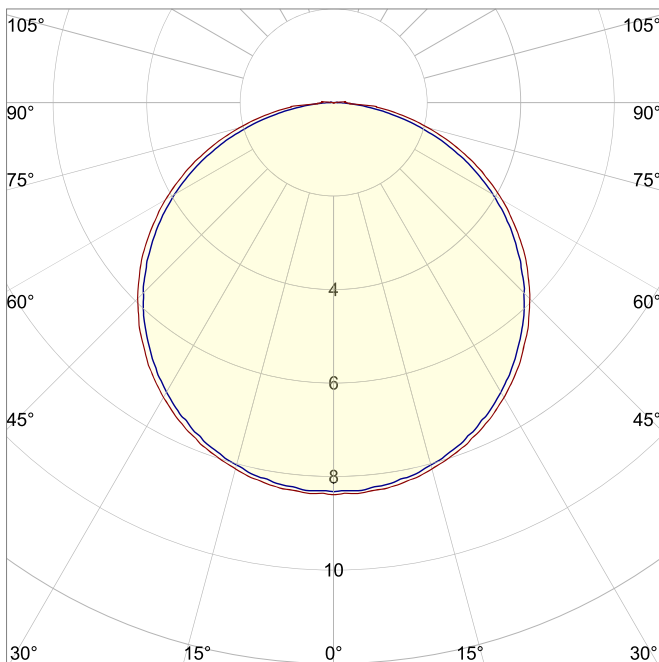

Spectra

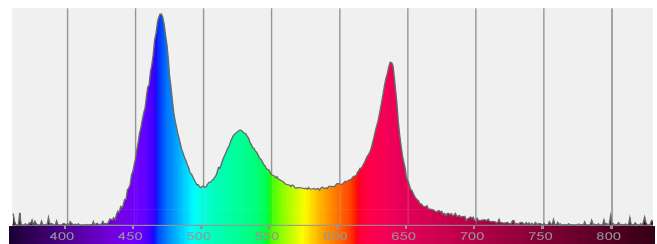

Beam details

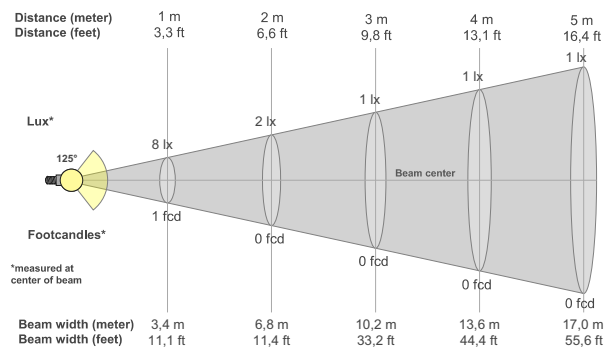

LDT/IES files are available on request

DOT CONFIGURATION

Light Source

4x RGB + 2x White (4000K)

Maximum Pixels per LED-Line

42

Pixel Pitch (LED-Line configuration)¹

var. LED-Dot distribution; min. spacing 85mm (3.346")

Remarks: (1) Center-to-center distance

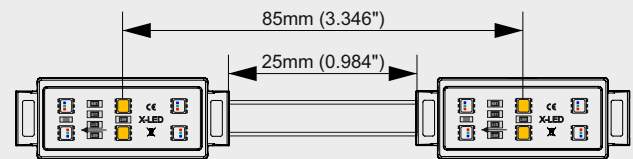

VISUAL PERFORMANCE METRICS

Color depth

32-bit RGBW

Color resolution

8-bits per channel (256 intensity levels per channel)

Refresh rate

PMW 3.6KHz

CONTROL

Control protocol

DMX-512A

DMX-Addressing

Manual-Addressing with XLED Node Mapper or XLED-PS8-RDM driver

ELECTRIC CHARACTERISTICS

Dimmable

Yes, DMX

Operating mode

Constant voltage

Operating voltage [V]¹

min. 21

typ. 24

Power consumption [W]¹

1.2

Lumen Maintenance (L80 @ Ta 50 °C/122 °F) [h]²

50.000

Measurement Tolerances: (1) ± 5%

Remarks: (2) All measurements are in compliance with the IES LM-80-08 testing procedures and evaluated in accordance with TM-21-11 guidelines.

TEMPERATURE & ENVIRONMENT

Ambient temperature	min. -30°C (-22°F)	max. +50°C (122°F)
Storage temperature	min. -40°C (-40°F)	max. +70°C (158°F)
Operating temperature ²	min. -30°C (-22°F)	max. +85°C (185°F)
Junction temperature ²	max. +100°C (212°F)	
Humidity	0 to 95%, non-condensing	
Environment	Outdoor, IP67, suitable for Coastal Environment	
Protection class	III	
IK - for resistance to mechanical shock class	IK10	
Fire protection (Housing)	UL94-V0	
Fire protection (Lens)	UL94-V2	

Performance temperatures are measured on „T_c“

TECHNICAL SPECIFICATION LINE

Sheathing color	Black or Grey	
Sheathing material	PVC	
Cable weight	55.6 gr./m (16.96 gr./ft)	
Conductors cross-section	2x 1mm ² (AWG17) + 3x 0,3mm ² (AWG22)	
Conductors material	Copper - AS	
Conductors insulation	Polyethylene	
Cable dimensions (W x H) ¹	3.00mm x 10.00mm (0.118"x0.394")	
LED-Line length ³	≤70m (229,66') (free pixel distribution)	
Cable type	60227 IEC 53 RVV According to IEC 60227-5-1979	
Fire protections certifications	EN 60332-1-2:2004 + A12:2020	
UV	Yes, UV stabilized	

Remarks: (1) according to ISO 2768-1m.

Remarks: (2) The performance must be adjusted depending on the temperature

Remarks: (2) Referring to the max. operating temperature / junction temperature of the LED

Remarks: (3) The total LED line length depends on the number of LED DOTs used and the pixel pitch. An exact voltage drop calculation is required.

CABLE BENDING & NON-BENDING LENGTH

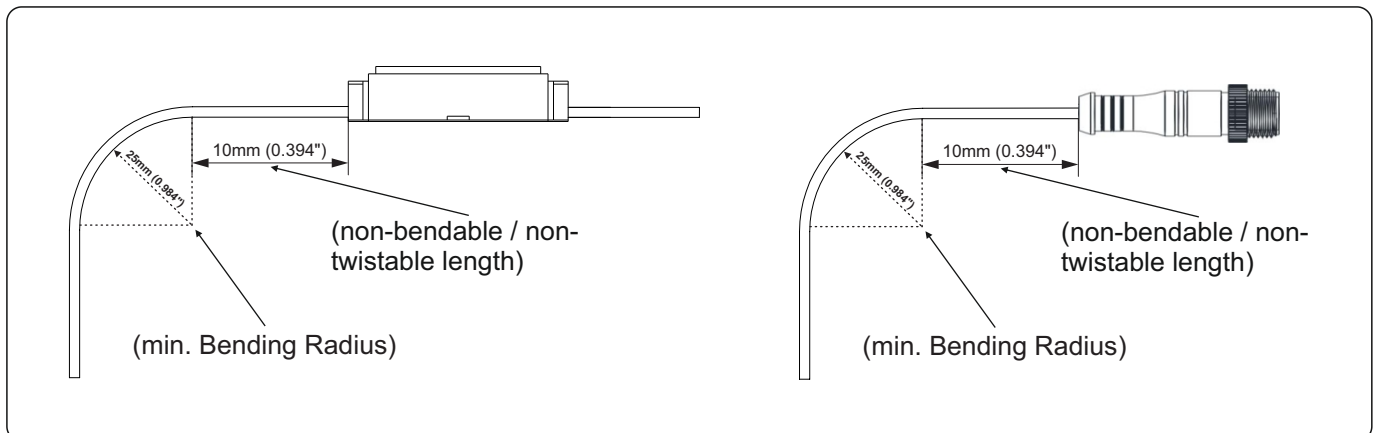

NOTE: Water ingress incurred due to excess cable bending/twisting will not be under warranty by Carl Stahl ARC.

LEAD ASSIGNMENT & CONNECTIONS

PIN#	Description	Color
1	Power +	RED
5	DATA -	YELLOW
2	DMX +	BLUE
3	N.C.	GREEN
4	Power - (GND)	BLACK

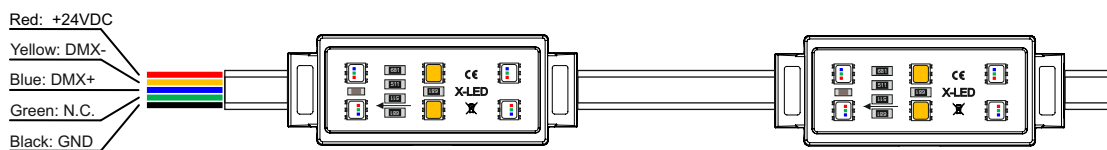

The wiring schematic shown above applies when connecting the LED Lines to the **XLED-PS8** power supply.

DMX addressing is carried out either via RDM or using the XLED Node Mapper (see relevant manual).

For the **XLED-LINE-EL44X-RGBW**, it is not necessary to connect the green wire to Pin 3 of the socket, as all green wires are not connected (N.C.).

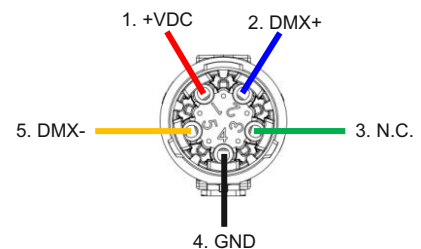

INSTALLATION & HANDLING

Whenever installing LED Dot Lines, please ensure that all of the following instructions are strictly followed.

Handle the strips with care, especially during transport. Do not hold or lift the strips by the cabled sections, as this may place the full weight of the dots on the cables, potentially causing damage (see image below).

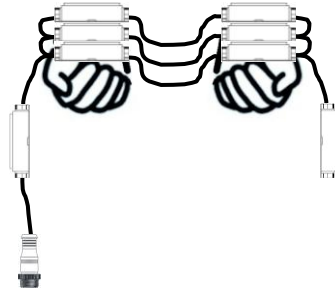

CAUTION - It is strongly recommended to maintain equal load distribution across all outputs of the PS8 driver. If perfect load balancing is not possible, strictly **DO NOT** connect more than 42 dots per output. It is also advised to evaluate the voltage drop along each line to ensure that the last dot receives at least the minimum required voltage. **DO NOT** connect more than 126 dots per group, and under no circumstances exceed 252 dots in total per PS8 driver. (For further reference, please refer to the instructions on page 13.)

IMPORTANT – The flat cable used in this product is plastic-based and therefore flexible, but also sensitive to mechanical stress. To prevent damage to the cables and the product, please follow these rules:

- Keep cables away from sharp objects.
- **DO NOT** use aggressive chemicals or solvents during installation.
- **DO NOT** pull on the cables during strip installation.
- Always leave a small amount of slack between each dot before fixing them in place, the cable must not be under tension.
- **DO NOT** twist, knot, crush, or step on the flat cables.
- **DO NOT** bend the cable over its minor axis (see image below).

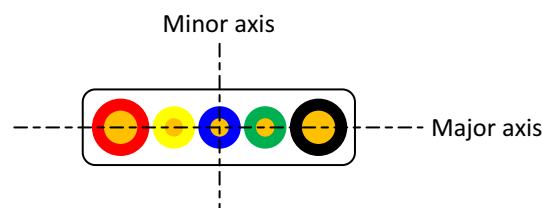

If bending is necessary, only bend along the flat cable's major axis of symmetry. Please follow the minimum clearances as indicated on page 11 (cable bending & non-bending lengths).

DO NOT create sharp bends or exceed the defined non-bending zones

CONNECTOR HANDLING & INSTALLATION SAFETY REQUIREMENTS

Correct handling of the connectors is essential to ensure long-term mechanical integrity and sealing performance. Installers must follow the installation and operating procedures exactly as described. Failure to comply can result in damage to the connector assembly and loss of sealing capability.

Mandatory Handling Instructions:

- All plug connections must be inserted and removed **strictly along their main (longitudinal) axis**.
- **Do not bend, twist, or lever** the connectors during removal. Any extraction force applied perpendicularly to the connector's axis is strictly prohibited.
- If a connector appears difficult to disconnect, apply:
 - A **firmer actuation** of the release/clicking mechanism.
 - A **higher axial pull-out force**, without any lateral movement.

Bending a connector during disconnection can stress the internal threaded components, potentially loosening the nut or damaging the plastic threads. This leads to compromised sealing and mechanical reliability.

These requirements must be understood and strictly followed by all installation personnel.

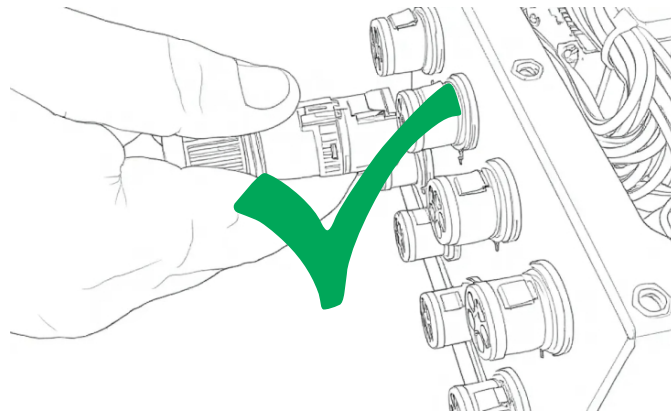

All plug connections must be inserted and removed **strictly along their main (longitudinal) axis**.

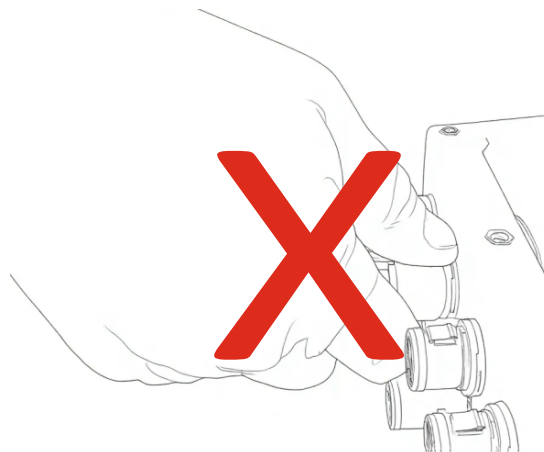

Do not bend, twist, or lever the connectors during removal.

SYSTEM CONFIGURATION

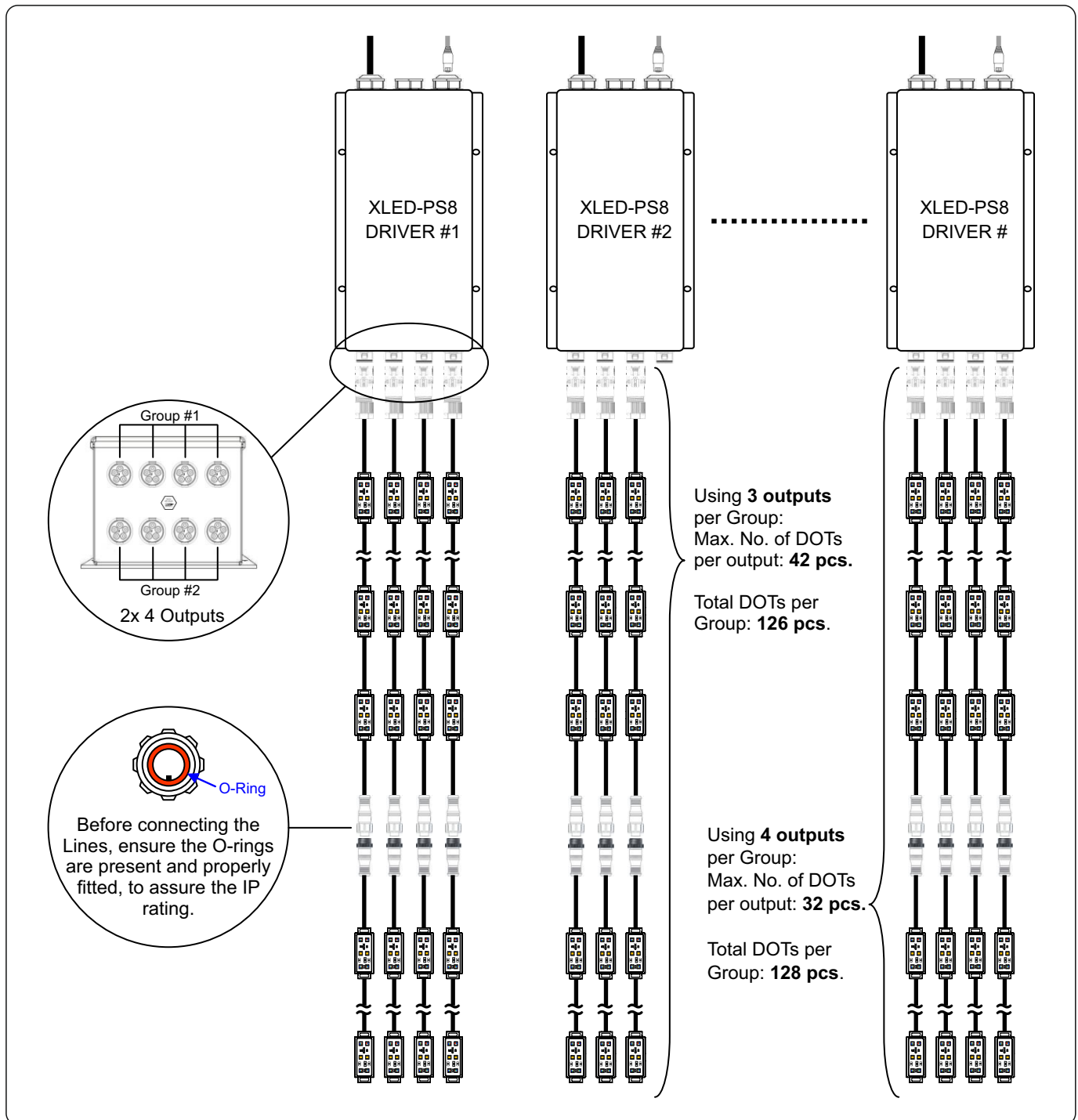

- To guarantee the system's IP rating, ensure, as mentioned above, that the O-ring is present inside each female connector before joining the strips. Tighten and screw the connectors together securely to ensure a IP rating and flawless connection.
- Whenever possible, secure the connection cables using cable ties.
- If necessary, at the end of the installation, set up the LED Line addresses via the **XLED-PS8**, using one of the two available procedures: *hardware* or *software* (see XLED-PS8 user guide for reference).
- Perform a functional check on all LED Lines using the **XLED-PS8** self-diagnostic test. Check for any signal irregularities (see XLED-PS8 user guide for reference).
- **WARNING:** For your own safety, avoid looking directly into the LED light source.

INSTALLATION & SAFETY INSTRUCTIONS



Devices must be installed by qualified personnel in compliance with all pertaining regulations.

- Before installation, please visit the product page at www.x-led.de to download the latest version of the installation instructions.
- Only authorized and trained personnel should operate the device. For technical assistance or service-related inquiries, please contact **Carl Stahl ARC GmbH** directly.
- Always refer to the technical parameters in the datasheet. All items are subject to technical modifications.
- The LED modules and all their components must not be mechanically stressed.
(Avoid excessive force, e.g. from screws or excessive bending.)
- Follow all safety instructions included in this manual to ensure correct powering of the device. Refer to the User Manual for proper usage guidelines.
- Consult the circuit diagram to ensure correct wiring.
- Important! Before performing any work, ensure the device is completely disconnected from the main power supply.
- Do not solder cable strands. Use cable strand sleeves instead.
- Make sure protection against line voltage shock is provided during installation. We recommend securing the installation by RCD circuit breakers.
- Flawless electrical connectivity must be ensured at all times.
- Do not install or remove LED-Dots / LED-Lines while the device is powered. Connecting LED-Dots / LED-Lines to a powered device may cause damage and will void the product warranty.
- Mind the operating temperatures and ambient temperatures of the device according to the technical data sheet.
IMPORTANT: In the unlikely event of continuous operation of the LED modules at full RGBW output (100%), the ambient temperature must not exceed 45°C. Solar radiation and the resulting self-heating of the module must also be taken into account, as they may lead to increased temperatures.
- Do not install the device on flammable surfaces. Maintain a minimum safety distance of 0.1m (3.937") from flammable materials. Adjacent components must be temperature-resistant up to 90°C (194°F).
- Do not place heat insulation materials on the device.
- Ensure the input/output voltage matches the specified range. Over-voltage or under-voltage may damage the LED-Line.
- Do not attempt installation in wet or extreme weather conditions.
- Do not leave or expose the LED Line to wet, rainy, or snowy environments when it is not connected or when an end cap is not in use.
- Do not operate the device in an electric circuit shared with inductive consumers, such as: Fluorescent lamps, Gas discharge lamps, Ventilators. Activating inductive consumers in the same circuit may cause damage to the operating device.
- Do not modify the device in any way. No liability will be assumed for damage caused by alterations, improper use, or faulty installation.
- Ensure that the LED-Line is not accessible to unauthorized persons, especially in public or commercial spaces.
- During operation, it is possible for the product to generate heat. To ensure safety and guarantee its longevity, it is imperative that touching or conducting maintenance work on the product is strictly prohibited while it is in an active or heated state.
- The LED modules, both in operation and in storage, must not come into contact with aggressive chemical substances.
- Pay attention to standard ESD precautions when installing the modules.
- The device must NOT be installed in confined spaces without a constantly circulating air flow.
- Do NOT use the LED Dots / LED Lines if the housing, cable or sealing are damaged.

TEST & CERTIFICATION

Compliant with:	Remark:
2011/65/EU	RoHS 2 Directive
2015/863/EU	RoHS 2 Directive
2014/53/EU	Radio Equipment Directive
EN 61547:2009	EMC immunity requirements
IEC 60332-1-2	EN 60332-1-2:2004/A12:2020
UL 94-2013	Vertical burn test // IEC 60695-11-10:2013 + IEC 60695-11-4:2011
IEC 60695-2-11	Glow-wire flammability test (GWEPT) - IEC 60695-2-11:2021
1907/2006/EU	Compliance with EU regulations regarding the registration, evaluation, authorization, and restriction of chemical substances, as well as the permissible limits of SVHC (Substances of Very High Concern). REACH Regulation 1907/2006/EU.
EN IEC 55015:2019 + A11:2020	Limits and measurement methods for radio interference caused by electrical lighting equipment and similar electrical appliances.
EN 63000:2019	Technical documentation for the assessment of electrical and electronic equipment regarding the restriction of hazardous substances (IEC 63000:2016)
EN 61347:2021	Devices for lamps - Part 1: General and safety requirements (IEC 61347-1:2015 + A1:2017) Devices for lamps - Part 2: Particular requirements for electronic controlgear for LED modules
EN 60529:1991	Degrees of protection provided by enclosures (IP Code) (AC:1993 + A1:2000 + A2:2013 + AC:2016 + A2/AC:2019) German version EN 60529:1991 + A1:2000 + A2:2013
GB/Z30418-2013	IEC 62262 - Degrees of protection provided by enclosures for electrical equipment against external mechanical impacts (IK10 code)

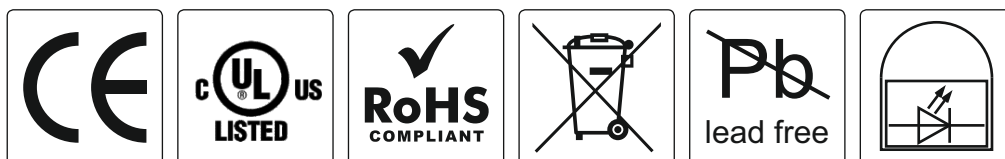

TEST & CERTIFICATION

Compliant with:	Remark:
EN 62471:2008	Photobiological safety of lamps and lamp systems
EN 62493:2015	Assessment of lighting equipment related to human exposure to electromagnetic fields
EN IEC 60598-1:2021 + EN IEC 60598-2-1	General requirements and tests & particular requirements - fixed general purpose luminaires
DIN EN ISO 4892-3	UV aging and frost simulation - DIN EN ISO 4892-3, method A, cycle 2
DIN EN ISO 9227	Saltwater spray test
DIN EN ISO 20105	Greyscale evaluation DIN EN ISO 20105-A02:1994-10
ANSI C136.31 3G	Vibration withstand capability and vibration test methods. EN 60598-1; IEC 60068-2-6:2007 EN 60068-2-6: 2008 ETSI EN 300 019-2-2 EN IEC 60068-2-64:2008 / A1:2019

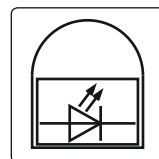
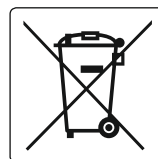
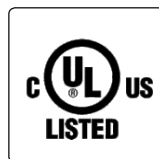

SAFETY INSTRUCTIONS & POWER SUPPLY REQUIREMENTS

To ensure the safe and reliable operation of both the LED-DOTs and our power supply, it is crucial to install surge protection devices to safeguard both the branch circuit and the connected equipment. Always adhere to local electrical codes.

Ensure that protective measures are in place to address:

1. Short Circuiting
2. Electrical Overloading
3. Over-Heating due to excessive operating voltage

LED CHARACTERISTICS

LEDs are semiconductor devices whose performance is subject to inherent variability within the semiconductor industry. To ensure consistent performance across a product, LED manufacturers sort LEDs into bins based on preset parameters such as forward voltage, brightness, etc. This "binning" process is purely a sorting function and not a correction process. Variations in the manufacturing process inevitably result in different binning distributions across production batches. Carl Stahl ARC uses the closest binned LEDs in its products to minimize variations within the model range. As with all electronic components, LED output decreases over time – a phenomenon known as lumen degradation. Therefore, it is nearly impossible to expect identical photometric performance from two LED products with different service life spans. The rate of LED degradation depends on various factors, such as operating efficiency, duration of continuous operation, and, most importantly, environmental conditions (e.g., ambient temperature). When operating under optimal temperature conditions and with proper ventilation, LEDs enjoy a longer lifespan compared to conventional light sources. When using or installing LEDs, care should be taken to ensure that the devices operate within the conditions specified in the respective product documentation.

CLEANING & MAINTENANCE

Regular cleaning of the product is required to maintain its performance and longevity. The process is straightforward but must be done regularly to prevent the buildup of dirt and dust, which can lead to an increase in temperature and a decrease in light output. Use solvent-free cleaning agents only and do not employ aggressive chemicals or high pressure cleaner. Ensure that the LED-DOT is turned off and has cooled down completely. Operate device only after complete drying.

WARRANTY

We provide a 5-year warranty for our **XLED-LINES** & **XLED-DOTs** starting from the date the goods are delivered to the customer. Any other system-related products (e.g. products from other manufacturers) are covered by their standard warranty terms.

For interior installations, a failure rate of up to 3% and for exterior installations, a failure rate of up to 5% may occur. Please note that these failure rates do not constitute a warranty claim.

Failures, damage, or consequential damage to the LED-DOTs or LED-LINES caused by improper installation, mounting, or handling are not covered under the warranty. Visual changes due to UV exposure, salt, or other environmental factors that do not affect the functional behavior of the product are not covered by the warranty. Damage resulting from exceeding the specified operating temperature limits is not covered. It is the responsibility of the client to ensure that the operating temperature stays within the recommended range.

We advise ordering a sufficient quantity of spare parts for future needs. For professional replacement and installation, we offer training by our specialists. Compliance with our installation and maintenance guidelines is a requirement for this warranty to be valid.

Issues arising due to site and application conditions that are not specifically addressed, will not be covered by the warranty unless the client has informed us of these conditions in advance. Installation must be performed by trained and qualified personnel to ensure the warranty is valid.

For all other conditions and claims, our General Sales and Planning Terms apply. These terms are available for download on our website.

SERVICE CONDITIONS

Service and repair requests must be accompanied by proof of purchase and a detailed description of the issue. Service is only available if the product (e.g. LED-Line, power supply) has been installed, operated, and maintained in accordance with our guidelines. Any modification or unauthorized repair of the product will void the warranty.

SERVICE AND SUPPORT

If any issues arise with one of our products, customers can contact our service department for support. Our team will assist with troubleshooting and, if necessary, arrange for repairs or replacements in line with the warranty terms. We provide technical support via phone, email, or online chat. For more complex service needs, our trained technicians are available for on-site support, subject to additional charges. Service requests can be submitted through our website or directly to our customer support team.

CONTACT



Carl Stahl ARC GmbH
Siemensstrasse 2
73079 Suessen
GERMANY

Phone: +49 (0) 7162/948 150 300 | Fax: +49 (0) 7162/948 150 305
E-Mail: x-led@carlstahl-arc.com

COPYRIGHT:

© Carl Stahl ARC GmbH. All rights reserved.

Specifications are subject to change without notice.

No representation or warranty as to the accuracy or completeness of the information included herein is given and any liability for any action in reliance thereon is disclaimed. All trademarks are owned by Carl Stahl ARC GmbH or their respective owners.

In the interest of continuous product improvement, we reserve the right to change specifications, setup and maintenance instructions, or product functionality at any time and without prior notice.

ENVIRONMENTAL SAFETY AND WASTE DISPOSAL



This device must be disposed of at a suitable, legally regulated disposal center that allows for the recycling of electrical and electronic equipment, components, and materials once it reaches its end of life (EOL). Proper disposal in accordance with environmental safety regulations and modern waste management procedures significantly reduces the negative impact of these materials on the environment and public health while ensuring the correct recycling, reuse, and redistribution of key components.

Unlawful disposal of this device and its materials is strictly prohibited. Any inadequate or illegal disposal practices may result in administrative sanctions or penalties, as per the applicable laws and regulations in your country.

Carl Stahl

ARCHITEKTUR

CARL STAHL ARC GMBH
Siemensstraße 2
D-73079 Süssen

Fon +49 (0) 7162 / 948 150 300
Fax +49 (0) 7162 / 948 150 305

x-led@carlstahl-arc.com
www.x-led.de